

7.6 mm (0.3 inch)/10.9 mm (0.43 inch) Seven Segment Displays

Technical Data

5082-761X Series
5082-762X Series
5082-765X Series
5082-766X Series
5082-773X Series
5082-7740
5082-775X Series
5082-7760
HDSP-360X Series
HDSP-460X Series
HDSP-E15X Series

Features

- **Industry Standard Size**
- **Industry Standard Pinout**
7.62 mm (0.300 inch) DIP Leads on 2.54 mm (0.100 inch) Centers
- **Choice of Colors**
Red, AlGaAs Red, High Efficiency Red, Yellow, Green
- **Excellent Appearance**
Evenly Lighted Segments
Gray Package Gives Optimum Contrast
± 50° Viewing Angle
- **Design Flexibility**
Common Anode or Common Cathode
Single Digits
Left or Right Hand Decimal Point
± 1. Overflow Character
- **Categorized for Luminous Intensity**
Yellow and Green Categorized for Color
Use of Like Categories Yields a Uniform Display
- **High Light Output**
- **High Peak Current**
- **Excellent for Long Digit String Multiplexing**
- **Intensity and Color Selection Available**
See Intensity and Color Selected Displays Data Sheet
- **Sunlight Viewable AlGaAs**



segment displays are designed for viewing distances up to 3 metres (10 feet) and 5 metres (16 feet). These devices use an industry standard size package and pinouts. All devices are available as either common anode or common cathode.

Description

The 7.6 mm (0.3 inch) and 10.9 mm (0.43 inch) LED seven

Devices

Red 5082-	AlGaAs ⁽¹⁾ Red HDSP-	HER ⁽¹⁾ 5082-	Yellow 5082-	Green HDSP-	Description	Package Drawing
7730		7610	7620	3600	7.6 mm Common Anode Left Hand Decimal	A
7731		7611	7621	3601	7.6 mm Common Anode Right Hand Decimal	B
7740		7613	7623	3603	7.6 mm Common Cathode Right Hand Decimal	C
7736		7616	7626	3606	7.6 mm Universal ± 1. Overflow Right Hand Decimal ^[2]	D
7750	E150	7650	7660	4600	10.9 mm Common Anode Left Hand Decimal	E
7751	E151	7651	7661	4601	10.9 mm Common Anode Right Hand Decimal	F
7760	E153	7653	7663	4603	10.9 mm Common Cathode Right Hand Decimal	G
7756	E156	7656	7666	4606	10.9 mm Universal ± 1. Overflow Right Hand Decimal ^[2]	H

Notes:

1. These displays are recommended for high ambient light operation. Please refer to the HDSP-E10X AlGaAs and HDSP-335X HER data sheet for low current operation.
2. Universal pinout brings the anode and cathode of each segment's LED out to separate pins. See internal diagram D.
3. Universal pinout brings the anode and cathode of each segment's LED out to separate pins. See internal diagram H.

These displays are ideal for most applications. Pin for pin equivalent displays are also available in a low current or high light

ambient design. The low current displays are ideal for portable applications. The high light ambient displays are ideal for high light ambients or long string

lengths. For additional information see the Low Current Seven Segment Displays, or High Light Ambient Seven Segment Displays data sheets.

Package Dimensions

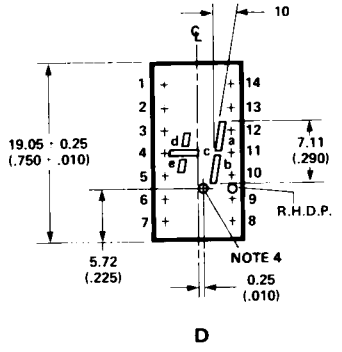
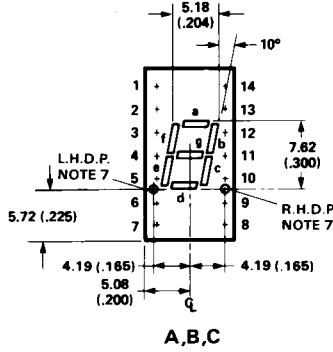

PIN	FUNCTION			
	A	B	C	D
1	CATHODE-a	CATHODE-a	NO PIN	ANODE-d
2	CATHODE-f	CATHODE-f	CATHODE ⁽⁴⁾	NO PIN
3	ANODE ⁽³⁾	ANODE ⁽³⁾	ANODE-f	CATHODE-d
4	NO PIN	NO PIN	ANODE-g	CATHODE-c
5	NO PIN	NO PIN	ANODE-e	CATHODE-e
6	CATHODE-dp	NO CONN. ⁽⁵⁾	ANODE-d	ANODE-e
7	CATHODE-e	CATHODE-e	NO PIN	ANODE-c
8	CATHODE-d	CATHODE-d	NO PIN	ANODE-dp
9	NO CONN. ⁽⁵⁾	CATHODE-dp	CATHODE ⁽⁴⁾	NO PIN
10	CATHODE-c	CATHODE-c	ANODE-dp	CATHODE-dp
11	CATHODE-g	CATHODE-g	ANODE-c	CATHODE-b
12	NO PIN	NO PIN	ANODE-b	CATHODE-a
13	CATHODE-b	CATHODE-b	ANODE-a	ANODE-a
14	ANODE ⁽³⁾	ANODE ⁽³⁾	NO PIN	ANODE-b

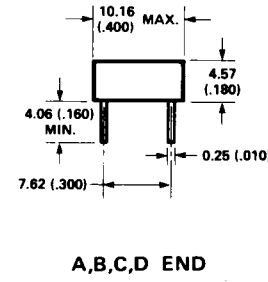
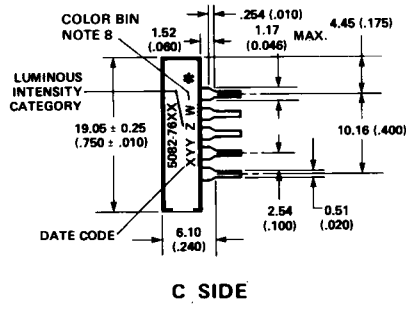
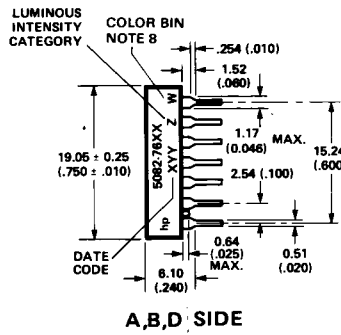

- NOTES;
1. DIMENSIONS IN MILLIMETRES AND (INCHES).
 2. ALL UNTOLERANCED DIMENSIONS ARE FOR REFERENCE ONLY.
 3. REDUNDANT ANODES.
 4. UNUSED DP POSITION.
 5. SEE INTERNAL CIRCUIT DIAGRAM.
 6. REDUNDANT CATHODE.
 7. SEE PART NUMBER TABLE FOR L.H.D.P. AND R.H.D.P. DESIGNATION.
 8. FOR YELLOW AND GREEN DEVICES ONLY.

*The Side View of package indicates Country of Origin.

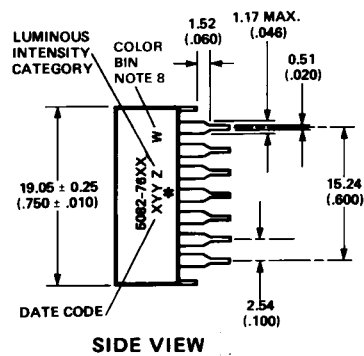
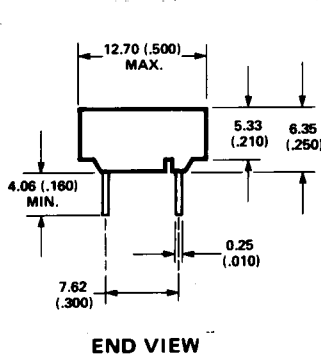
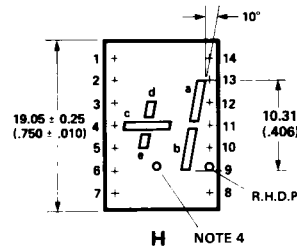
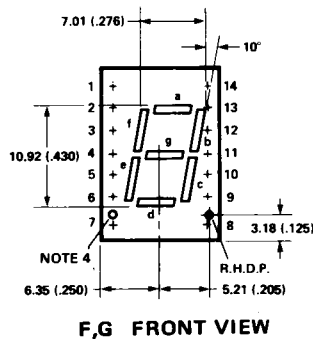
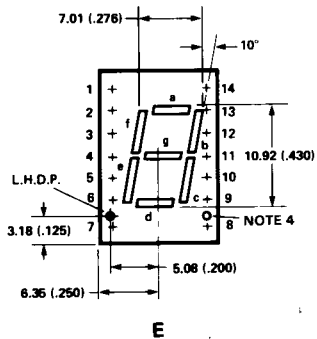

*The Side View of package indicates Country of Origin.

PIN	FUNCTION			
	E	F	G	H
1	CATHODE-a	CATHODE-a	ANODE-a	CATHODE-d
2	CATHODE-f	CATHODE-f	ANODE-f	ANODE-d
3	ANODE ⁽³⁾	ANODE ⁽³⁾	CATHODE ⁽⁴⁾	NO PIN
4	NO PIN	NO PIN	NO PIN	CATHODE-c
5	NO PIN	NO PIN	NO PIN	CATHODE-e
6	CATHODE-dp	NO CONN. ⁽⁵⁾	NO CONN. ⁽⁵⁾	ANODE-e
7	CATHODE-e	CATHODE-e	ANODE-e	ANODE-c
8	CATHODE-d	CATHODE-d	ANODE-d	ANODE-dp
9	NO CONN. ⁽⁵⁾	CATHODE-dp	ANODE-dp	CATHODE-dp
10	CATHODE-c	CATHODE-c	ANODE-c	CATHODE-b
11	CATHODE-g	CATHODE-g	ANODE-g	CATHODE-a
12	NO PIN	NO PIN	NO PIN	NO PIN
13	CATHODE-b	CATHODE-b	ANODE-b	ANODE-a
14	ANODE ⁽³⁾	ANODE ⁽³⁾	CATHODE ⁽⁴⁾	ANODE-b

Internal Circuit Diagram

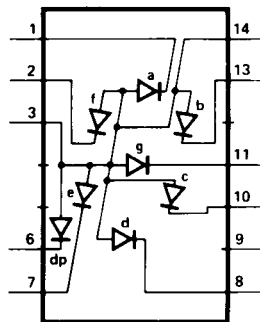

A

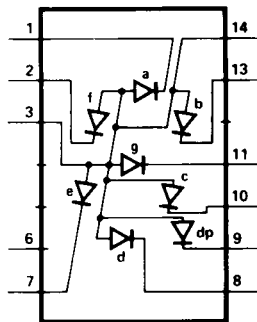

B

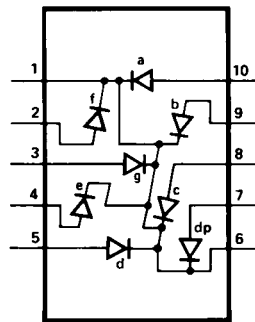

C

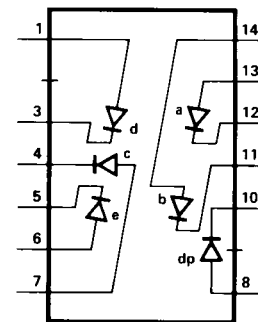

D

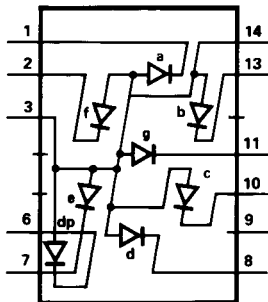

E

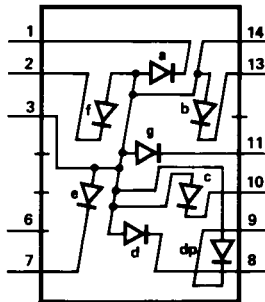

F

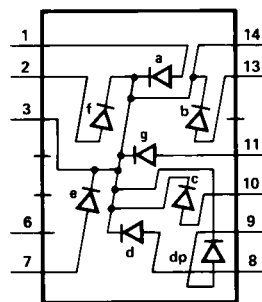

G

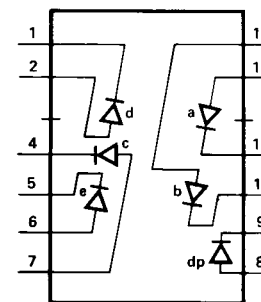

H

Absolute Maximum Ratings

Description	Red 5082-7700 Series	AlGaAs Red HDSP-E150 Series	HER 5082-7610/ 7650 Series	Yellow 5082-7620/ 7660 Series	Green HDSP-3600/ 4600 Series	Units
Average Power per Segment or DP	82	96	105	80	105	mW
Peak Forward Current per Segment or DP	150 ^[1]	160 ^[3]	90 ^[5]	60 ^[7]	90 ^[9]	mA
DC Forward Current per Segment or DP	25 ^[2]	40 ^[4]	30 ^[6]	20 ^[8]	30 ^[10]	mA
Operating Temperature Range	-40 to +100	-20 to +100 ^[11]	-40 to +100			°C
Storage Temperature Range	-55 to +100					°C
Reverse Voltage per Segment or DP	3.0					V
Lead Solder Temperature for 3 Seconds (1.59 mm [0.063 in.] below seating plane)	260					°C

Notes:

- See Figure 1 to establish pulsed conditions.
- Derate above 80°C at 0.63 mA/°C.
- See Figure 2 to establish pulsed conditions.
- Derate above 46°C at 0.54 mA/°C.
- See Figure 7 to establish pulsed conditions.
- Derate above 53°C at 0.45 mA/°C.
- See Figure 8 to establish pulsed conditions.
- Derate above 81°C at 0.52 mA/°C.
- See Figure 9 to establish pulsed conditions.
- Derate above 39°C at 0.37 mA/°C.
- For operation below -20°C, contact your local Agilent components sales office or an authorized distributor.

Electrical/Optical Characteristics at $T_A = 25^\circ\text{C}$

Red

Device Series	Parameter	Symbol	Min.	Typ.	Max.	Units	Test Conditions
5082-773X 5082-774X	Luminous Intensity/Segment ^[1,2] (Digit Average)	I_V	360	770		μcd	$I_F = 20\text{ mA}$
5082-775X 5082-776X			360	1100		μcd	$I_F = 20\text{ mA}$
All	Forward Voltage/Segment or DP	V_F		1.6	2.0	V	$I_F = 20\text{ mA}$
	Peak Wavelength	λ_{PEAK}		655		nm	
	Dominant Wavelength ^[3]	λ_d		640		nm	
	Reverse Voltage/Segment or DP ^[4]	V_R	3.0	12		V	$I_R = 100\ \mu\text{A}$
	Temperature Coefficient of V_F /Segment or DP	$\Delta V_F/^\circ\text{C}$		-2		$\text{mV}/^\circ\text{C}$	
	Thermal Resistance LED Junction-to-Pin	$R\theta_{\text{J-PIN}}$		280		$^\circ\text{C}/\text{W}/\text{Seg}$	

AlGaAs Red

Device Series	Parameter	Symbol	Min.	Typ.	Max.	Units	Test Conditions
HDSP-E15X	Luminous Intensity/Segment ^[1,2,5] (Digit Average)	I_V	8.5	15.0		mcd	$I_F = 20\text{ mA}$
	Forward Voltage/Segment or DP	V_F		1.8		V	$I_F = 20\text{ mA}$
				2.0	3.0	V	$I_F = 100\text{ mA}$
	Peak Wavelength	λ_{PEAK}		645		nm	
	Dominant Wavelength ^[3]	λ_d		637		nm	
	Reverse Voltage/Segment or DP ^[4]	V_R	3.0	15		V	$I_R = 100\ \mu\text{A}$
	Temperature Coefficient of V_F /Segment or DP	$\Delta V_F/^\circ\text{C}$		-2		$\text{mV}/^\circ\text{C}$	
Thermal Resistance LED Junction-to-Pin	$R\theta_{\text{J-PIN}}$		340		$^\circ\text{C}/\text{W}/\text{Seg}$		

High Efficiency Red

Device Series	Parameter	Symbol	Min.	Typ.	Max.	Units	Test Conditions
5082-761X	Luminous Intensity/Segment ^[1,2,6] (Digit Average)	I _V	340	800		μcd	I _F = 5 mA
5082-765X			340	1115		μcd	I _F = 5 mA
All	Forward Voltage/Segment or DP	V _F		2.1	2.5	V	I _F = 20 mA
	Peak Wavelength	λ _{PEAK}		635		nm	
	Dominant Wavelength ^[3]	λ _d		626		nm	
	Reverse Voltage/Segment or DP ^[4]	V _R	3.0	30		V	I _R = 100 μA
	Temperature Coefficient of V _F /Segment or DP	ΔV _F /°C		-2		mV/°C	
	Thermal Resistance LED Junction-to-Pin	Rθ _{J-PIN}		280		°C/W	

Yellow

Device Series	Parameter	Symbol	Min.	Typ.	Max.	Units	Test Conditions
5082-762X	Luminous Intensity/Segment ^[1,2] (Digit Average)	I _V	205	620		μcd	I _F = 5 mA
5082-766X			290	835		μcd	I _F = 5 mA
All	Forward Voltage/Segment or DP	V _F		2.2	2.5	V	I _F = 20 mA
	Peak Wavelength	λ _{PEAK}		583		nm	
	Dominant Wavelength ^[3,7]	λ _d	581.5	586	592.5	nm	
	Reverse Voltage/Segment or DP ^[4]	V _R	3.0	40		V	I _R = 100 μA
	Temperature Coefficient of V _F /Segment or DP	ΔV _F /°C		-2		mV/°C	
	Thermal Resistance LED Junction-to-Pin	Rθ _{J-PIN}		280		°C/W/Seg	

High Performance Green

Device Series	Parameter	Symbol	Min.	Typ.	Max.	Units	Test Conditions
HDSP-360X	Luminous Intensity/Segment ^[1,2] (Digit Average)	I_V	860	2700		μcd	$I_F = 10 \text{ mA}$
HDSP-460X			1030	4000		μcd	$I_F = 10 \text{ mA}$
All	Forward Voltage/Segment or DP	V_F		2.1	2.5	V	$I_F = 10 \text{ mA}$
	Peak Wavelength	λ_{PEAK}		566		nm	
	Dominant Wavelength ^[3,7]	λ_d		571	577	nm	
	Reverse Voltage/Segment or DP ^[4]	V_R	3.0	50		V	$I_R = 100 \mu\text{A}$
	Temperature Coefficient of V_F /Segment or DP	$\Delta V_F / ^\circ\text{C}$		-2		mV/ $^\circ\text{C}$	
	Thermal Resistance LED Junction-to-Pin	$R\theta_{\text{J-PIN}}$		280		$^\circ\text{C/W/Seg}$	

Notes:

1. Device case temperature is 25°C prior to the intensity measurement.
2. The digits are categorized for luminous intensity. The intensity category is designated by a letter on the side of the package.
3. The dominant wavelength, λ_d , is derived from the CIE chromaticity diagram and is that single wavelength which defines the color of the device.
4. Typical specification for reference only. Do not exceed absolute maximum ratings.
5. For low current operation, the AlGaAs HDSP-E10X series displays are recommended. They are tested at 1 mA dc/segment and are pin for pin compatible with the HDSP-E15X series.
6. For low current operation, the HER HDSP-335X series displays are recommended. They are tested at 2 mA dc/segment and are pin for pin compatible with the 5082-7650 series.
7. The Yellow (5082-7620/7660) and Green (HDSP-3600/4600) displays are categorized for dominant wavelength. The category is designated by a number adjacent to the luminous intensity category letter.

Red, AlGaAs Red

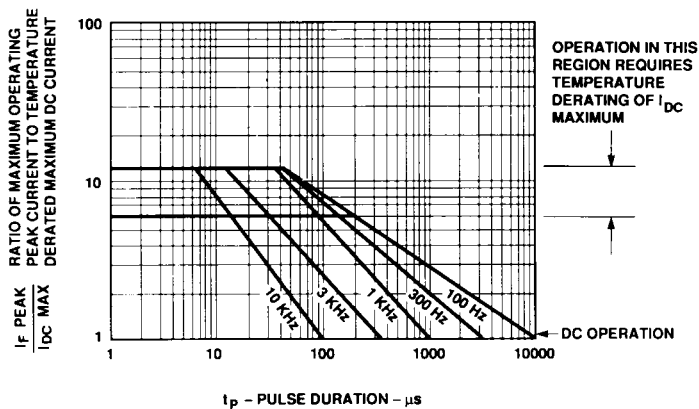

Figure 1. Maximum Tolerable Peak Current vs. Pulse Duration - Red.

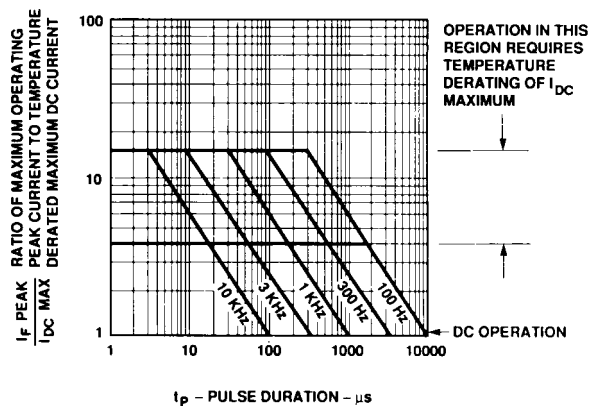

Figure 2. Maximum Allowed Peak Current vs. Pulse Duration - AlGaAs Red.

Red, AlGaAs Red (Continued)

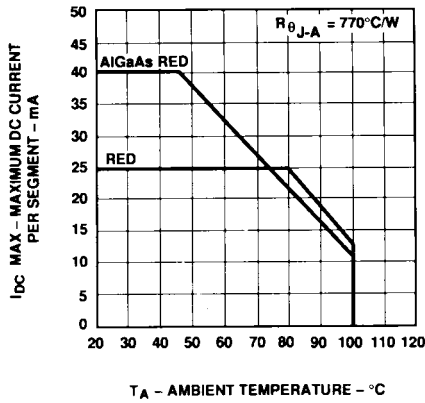

Figure 3. Maximum Allowable DC Current vs. Ambient Temperature.

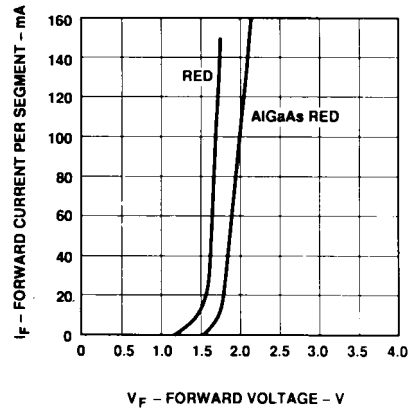

Figure 4. Forward Current vs. Forward Voltage.

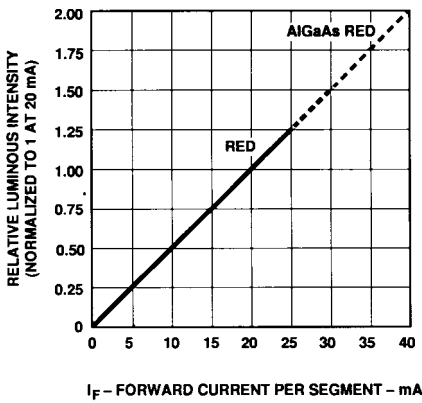

Figure 5. Relative Luminous Intensity vs. DC Forward Current.

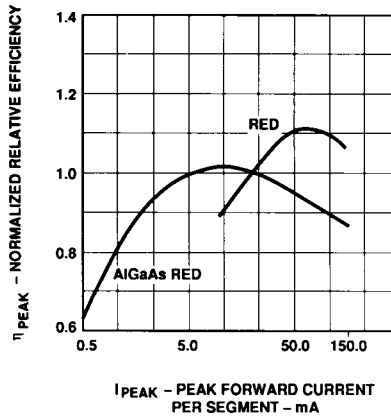

Figure 6. Relative Efficiency (Luminous Intensity per Unit Current) vs. Peak Current.

HER, Yellow, Green

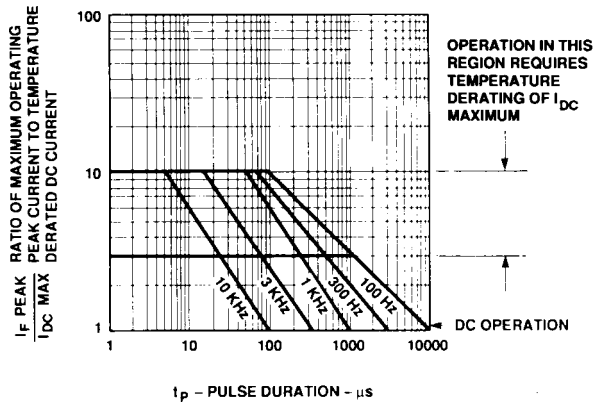

Figure 7. Maximum Tolerable Peak Current vs. Pulse Duration - HER Series.

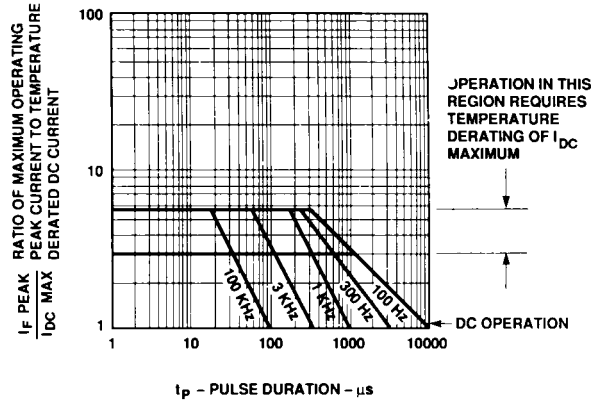
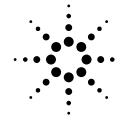

Figure 8. Maximum Tolerable Peak Current vs. Pulse Duration - Yellow Series.



HER, Yellow, Green (Continued)

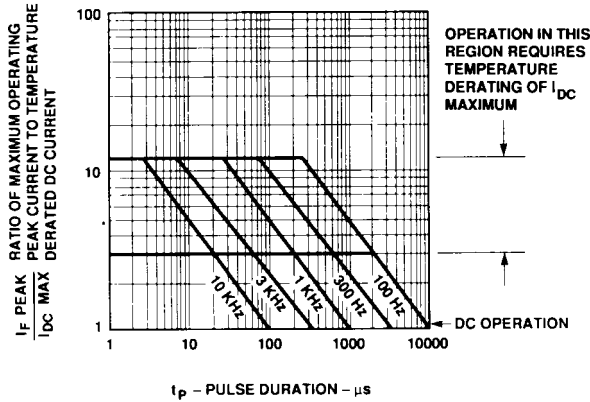

Figure 9. Allowable Peak Current vs. Pulse Duration - Green Series.

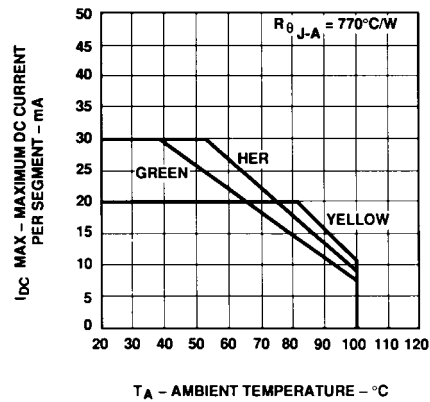

Figure 10. Maximum Allowable DC Current vs. Ambient Temperature.

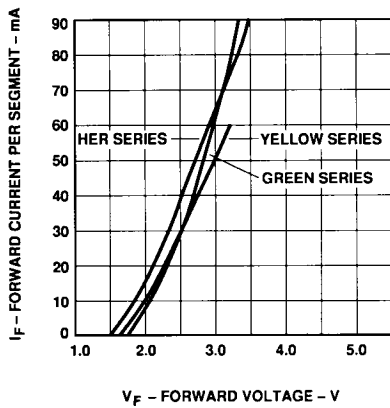

Figure 11. Forward Current vs. Forward Voltage.

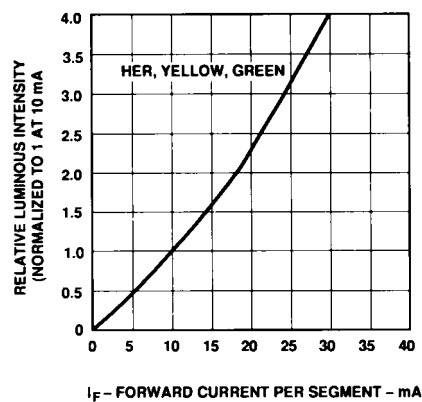

Figure 12. Relative Luminous Intensity vs. DC Forward Current.

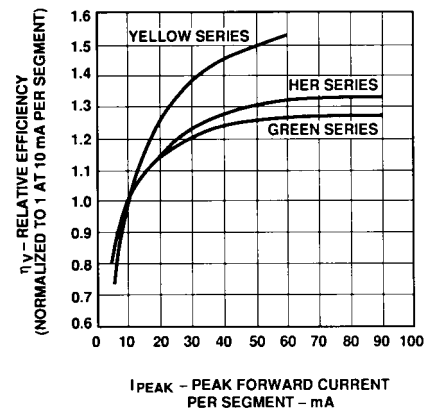

Figure 13. Relative Luminous Efficiency (Luminous Intensity per Unit Current) vs. Peak Current.

Contrast Enhancement

For information on contrast enhancement please see Application Note 1015.

Soldering/Cleaning

For information on soldering LEDs please refer to Application Note 1027.

www.semiconductor.agilent.com

Data subject to change.
Copyright © 1999 Agilent Technologies, Inc.
Obsoletes 5954-0870 (11/84), 5954-0874 (12/84)
5963-7394E (11/99)