

# Weasley Clock

## A Location Clock inspired by Harry Potter

Created By: Jordan Holmer, Brandon Howard, Peter Irgens, Theresa Le

COEN 4790: Developments in Computer Hardware with Dr. Cristinel Ababei

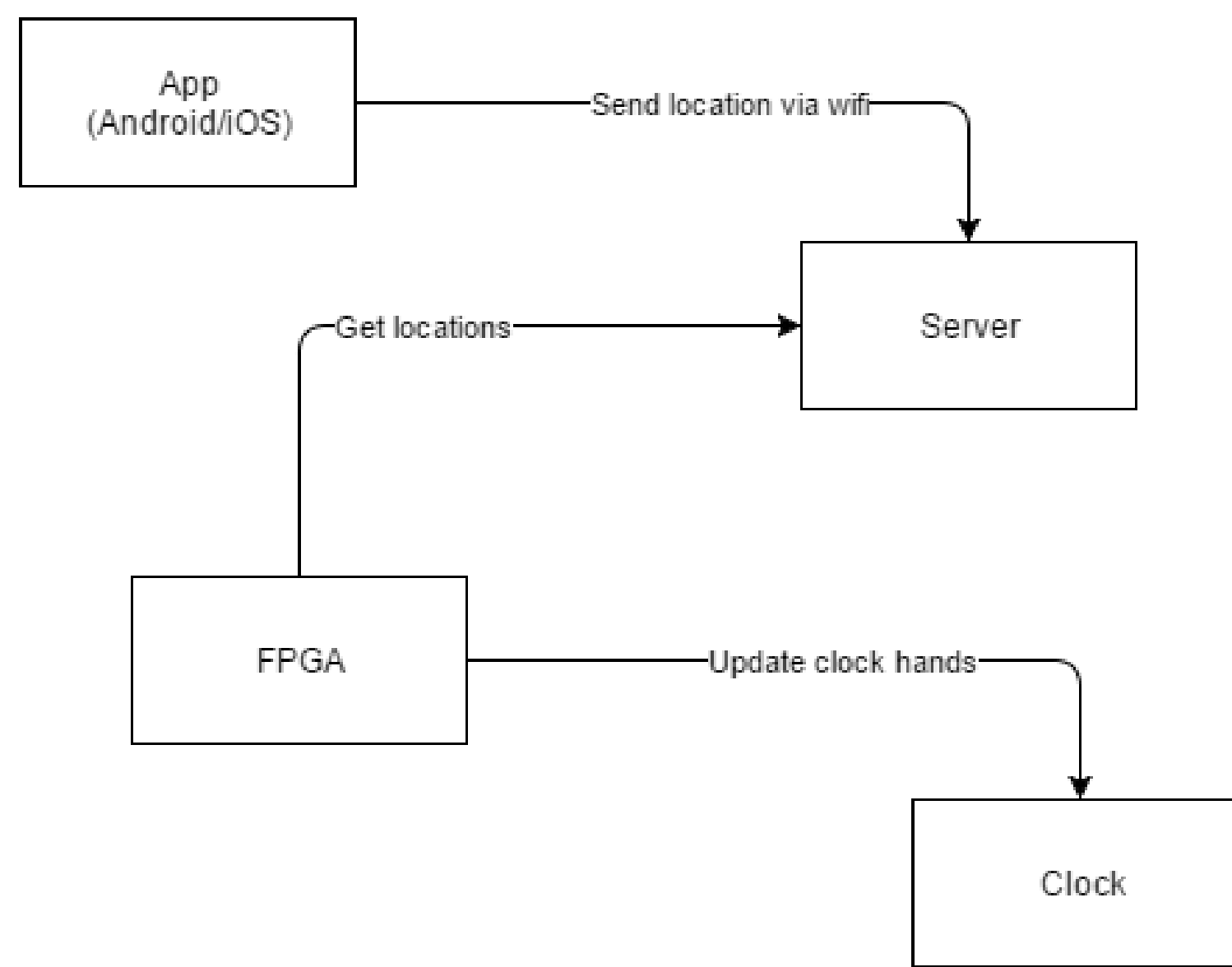
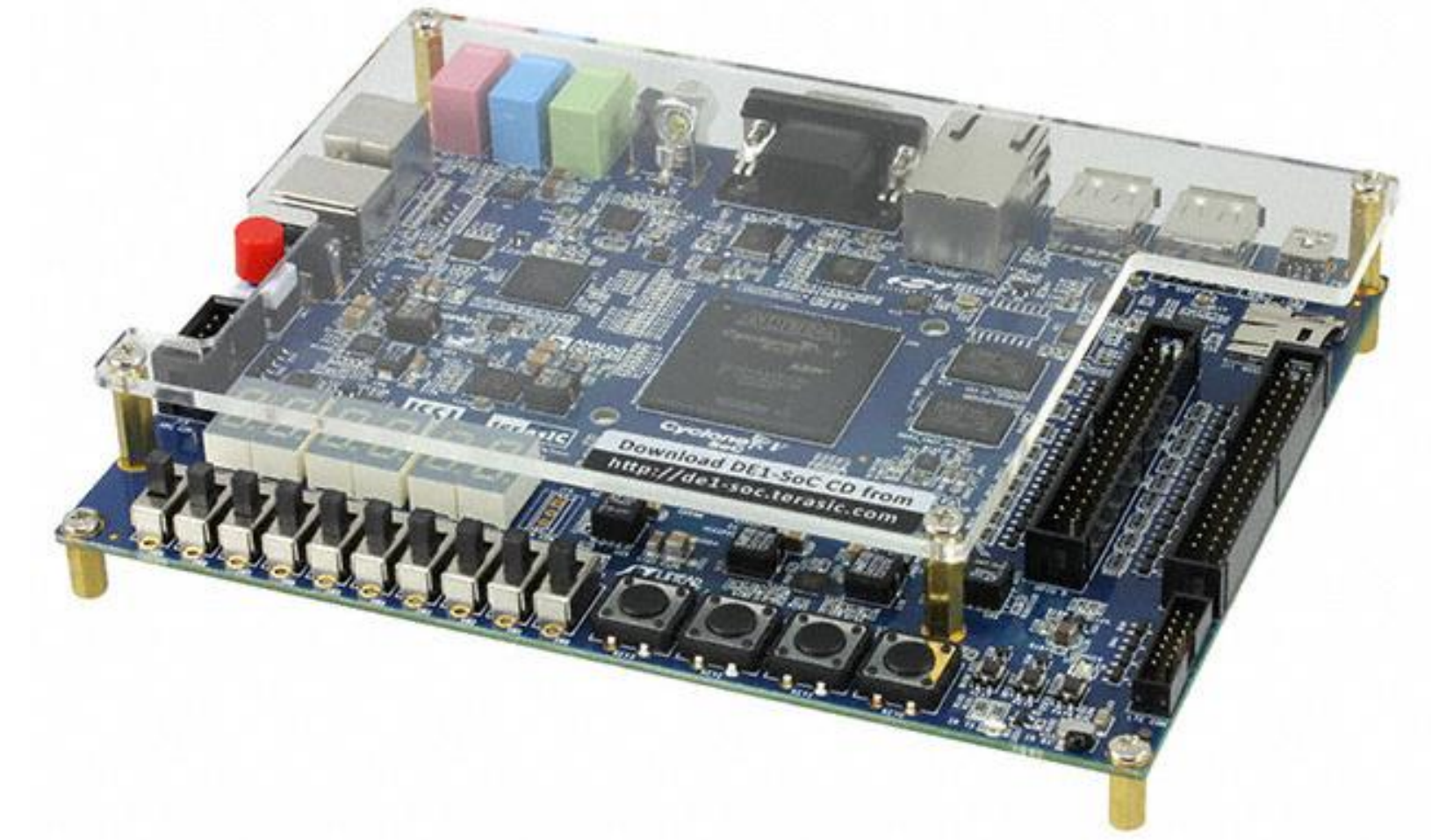

## Altera FPGA

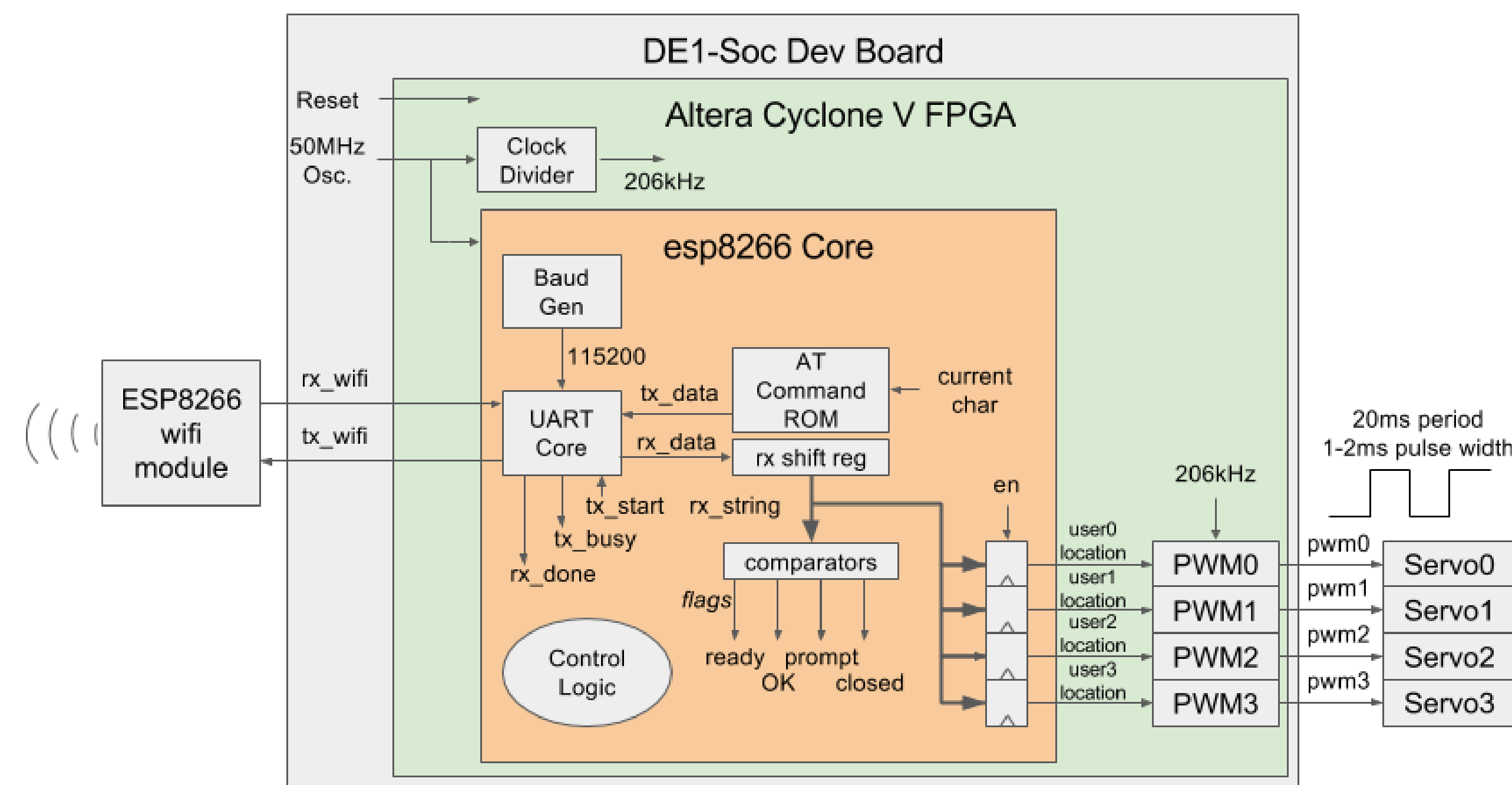

## Web Server



The web server is constantly listening for http requests. Two PHP scripts are hosted so the iPhone and Android apps make a request and perform specific functions.

<http://<server>/getLocations.php> returns a matrix of locations for each index.

<http://<server>/updateLocation.php?index=<>&location=<>> updates the specified index to the specified location.

## Android & iOS Applications

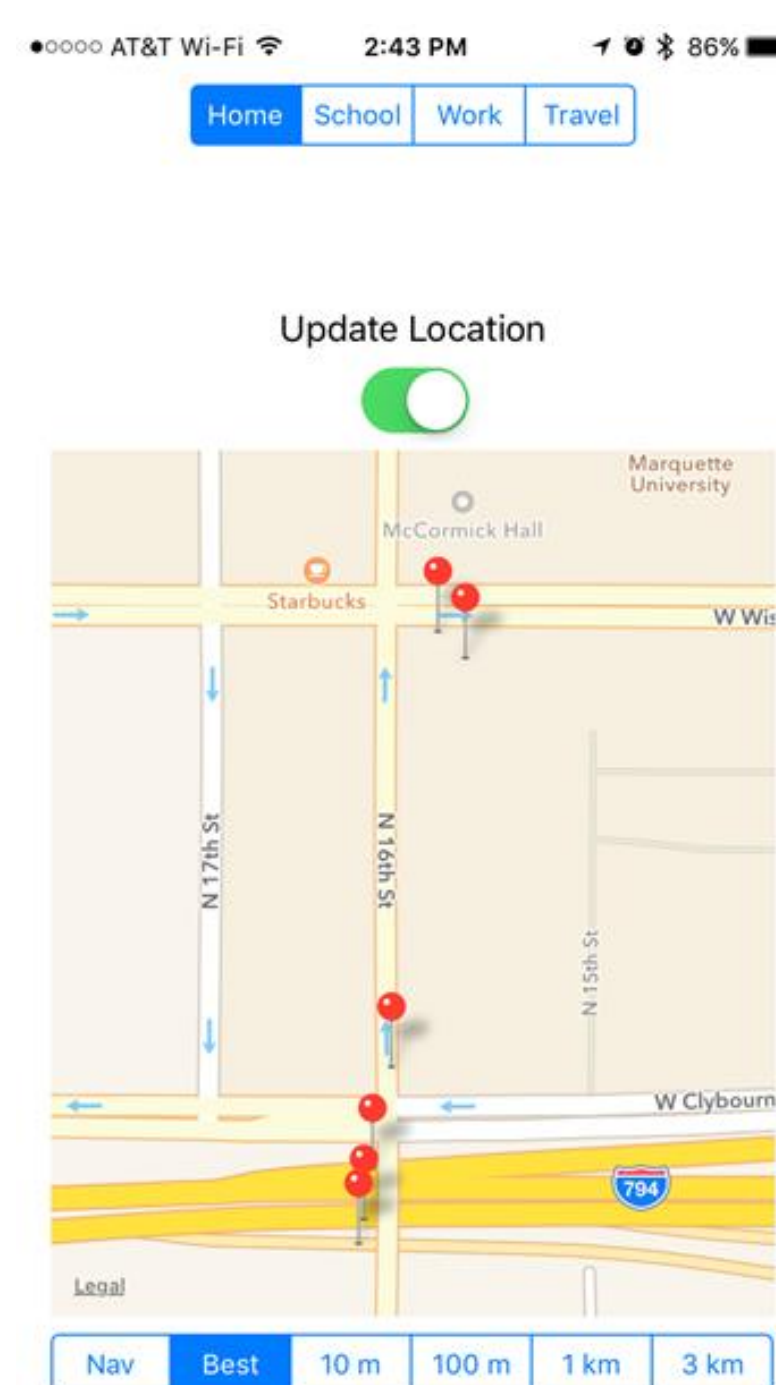
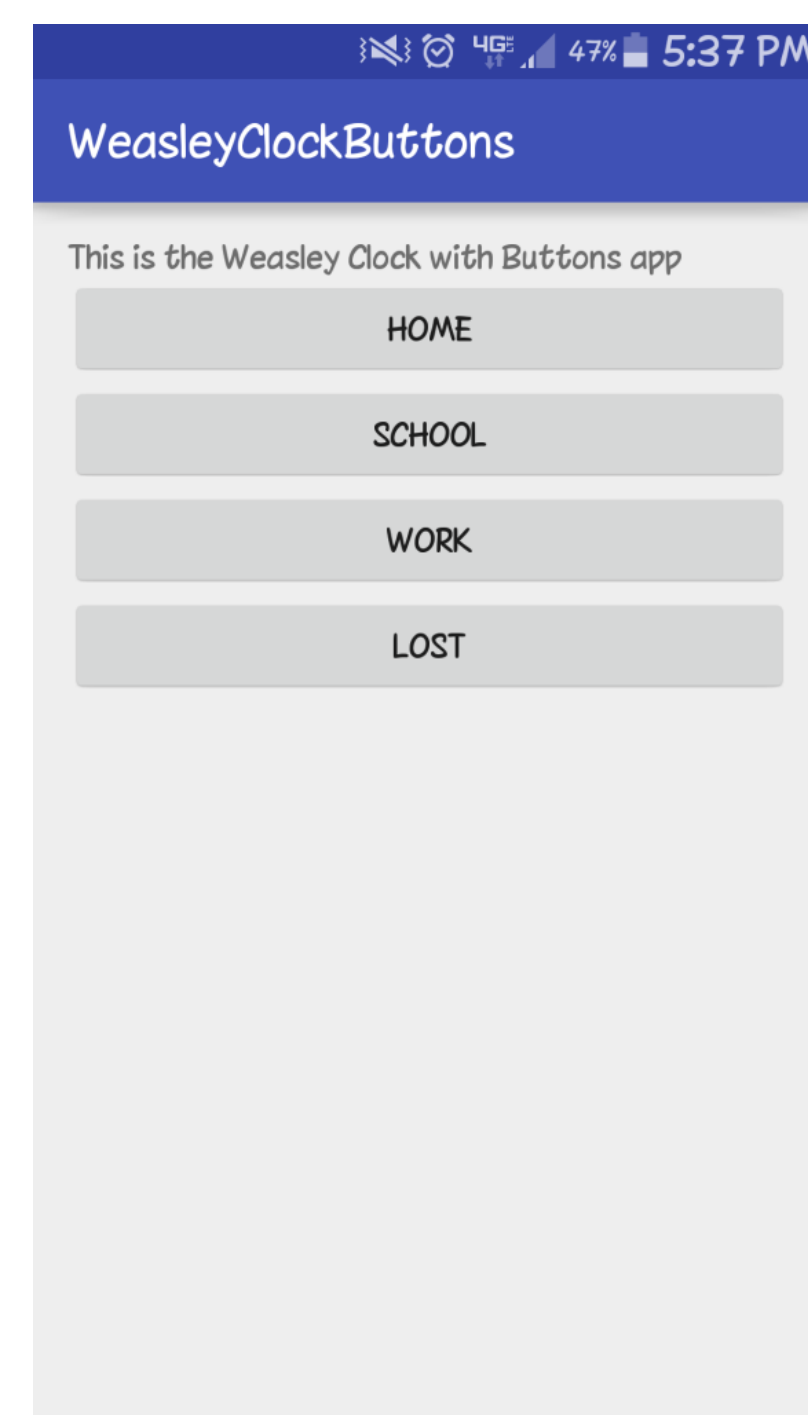

The Android and iOS apps get the user's location and categorizes it as Home, Work, School, or Lost. This position is sent to the web server periodically.

## Mechanical Clock

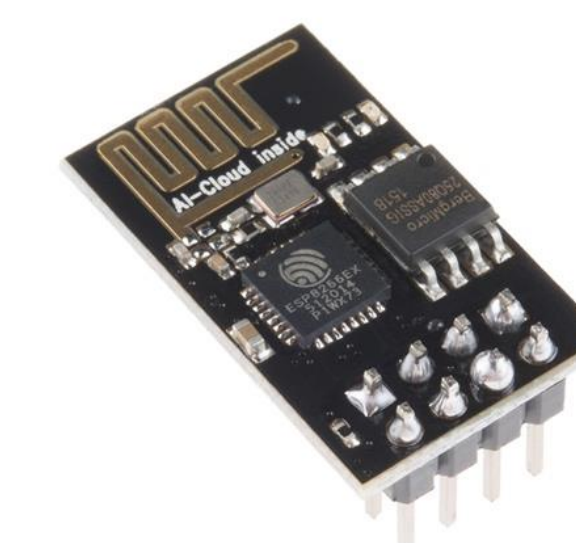

ESP8266 Wifi Module

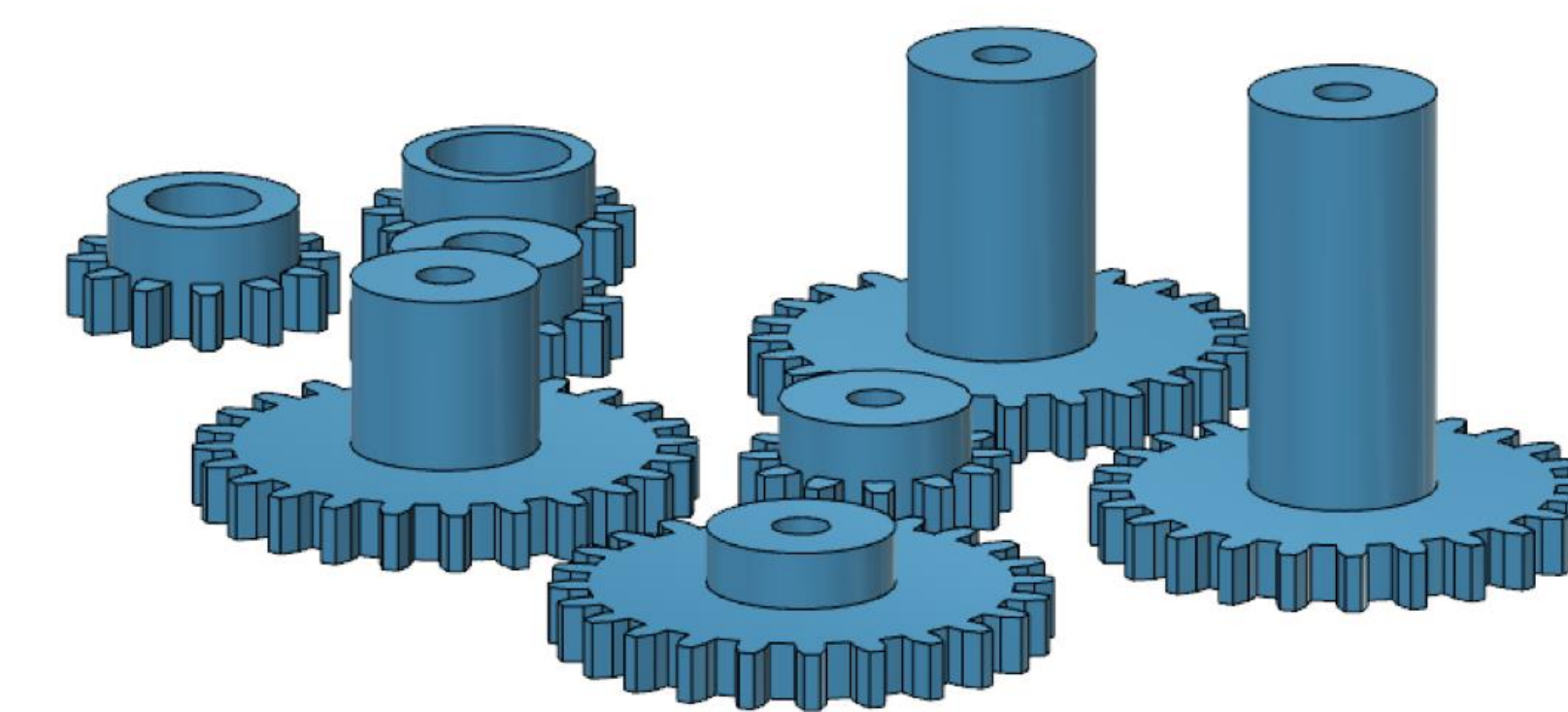

3D Model of Gears

Servo Motors

